

# Washer extractor

## WN6-8 Compass Pro



Washer featuring exceptional savings and effortless use



### Priority on people

Certified ergonomic design with a human-centered approach for an outstanding user experience

Compass Pro® microprocessor offers:

- Easy program selection
- Language selection
- Quick selection and option buttons for the most frequently used wash programs and options
- Wash program packages optimized on Economy, Performance and Time



### Long-term savings

Extremely low water and energy consumption – see table below

- High extraction force for efficient dewatering
- Super Balance guarantees the correct extraction force



### Pure control

Monitoring of the status of the equipment and performance from anywhere, allowing to take action to improve the business

- Washers connectable to OnE Laundry, the personal assistant for hygiene validation, process management and revenue management



### Global Advanced Hygiene

Global Advanced Hygiene program package\* with proven log 6 reduction\*\* disinfection of textiles through the laundry process, fulfilling the criteria of all local approved standards

### Main options

- Automatic liquid detergent supply (optional I/O board)
- Connection to booking- /payment- system or coin meter



Images shown are a representation of the product only and variations may occur.

\* Programs available in the standard library of all products, excluding products for specific segments where water temperature is not controllable.

\*\* Log 6 reduction equals to 99,999% viral infectivity reduction. The efficacy of reduction of SARS-CoV-2 and other pathogens in the process is confirmed by RISE (The Research Institute of Sweden) on the basis of Electrolux Professional laboratory data.

Main specifications				WN6-8			
Max. capacity	filling factor 1:9	kg/lb		8/18			
Drum,	volume	litre		75			
	diameter	ø mm		520			
Extraction		rpm		587			
G-factor				100			
Standard heating alternatives	electricity	kW		5.4 / 7.5			
Low energy heating alternatives	electricity	kW		2.0 / 3.0			
	steam			X			
	non-heated			X			
<b>Consumption data "ECO 60°C"</b>				EI		Steam***	
Total time		min		Full load, 8 kg	Half load**, 4 kg	Full load, 8 kg	Half load**, 4 kg
Water consumption (cold+hot)		litre		44	42	44	42
Energy consumption (motor/heating/hot water)		kWh		47+13	37+8	60+0	45+0
Steam consumption		kg		0.1/0.35/0.8	0.1/0.25/0.45	0.1/-	0.1/-
Residual moisture		%		-	-	1.75	1.05
				65	74	65	74

\* Water temperature 15°C cold water and 65°C hot water.

\*\* Programs with AS.

\*\*\* Depending on steam pressure.

Electrical connections					
Heating alternative	Main voltage		Heating power kW	Total power kW	Recommended fuse A
		Hz			
Electric heated	220-240V 1/1N -	50/60	2.0/3.0	2.3/3.4	16/16
	220-240V 1/1N -	50/60	5.4/7.5	5.7/7.8	25/35
	220-240V 3 -	50/60	2.0/3.0	2.2/3.4	10/10
	220-240V 3 -	50/60	5.4/7.5	5.7/7.8	16/25
	380-415V 3N/3 -	50/60	2.0/3.0	2.2/3.4	10/10
	380-415V 3N/3 -	50/60	5.4/7.5	5.7/7.8	10/16
	440V 3 -	50/60	5.4/7.5	5.7/7.9	10/16
	480V 3 -	60	5.4/7.5	5.7/7.9	10/16
	Steam or Non heated	220-480V 1 -	50/60	-	1.0

\* Total power and recommended fuse does not depend on the heating power in those cases.

Water and steam connection		WN6-8
Water valves	DN	20
Water pressure	kPa	200-600
Capacity at 300 kPa	l/min	20
Drain valve	ø mm	75
Draining capacity	l/min	170
Steam valve	DN	15
Steam pressure	kPa	300-600
Liquid detergent supplies		5
Floor requirements		
Frequency of the dynamic force	Hz	9.8
Floor load at max extraction	kN	1.6 ± 1.9
Sound levels		
Sound power/pressure level at extraction*	dB(A)	68/53
Sound power/pressure level at wash*	dB(A)	62/48
Heat emission		
% of installed power, max		5
Shipping data**		
Weight	net, kg	116
Shipping volume	m <sup>3</sup>	0.75
Accessories		
Steel base		x
Hose kits for water or steam		x
Fluff collector		x
Dimensions in mm		
A Width		660
B Depth		680
C Height		1135
D1		360
D2		425
E		1110
F		835
G		80
H		1035
I		215
J		125
K		1015
L		915
M		280
N		100
O		200
1 Operating panel	7 Drain valve	
2 Door opening ø 310 mm	8 Liquid detergent supply	
3 Detergent box	9 Electrical connection	
4 Cold water	10 Steam connection	
5 Hot water		
6 Re-used water		

Front and side panels in silver grey and dark blue (color samples can be ordered on part number 472998313).

\* Sound power levels measured according to ISO 60704.

\*\* Average data. Crated weight/shipping volume depends on configuration. Please contact logistics for exact measures.

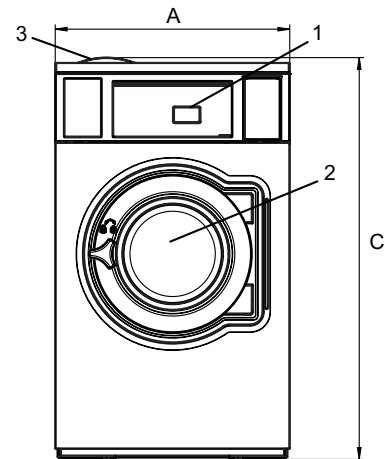

Front

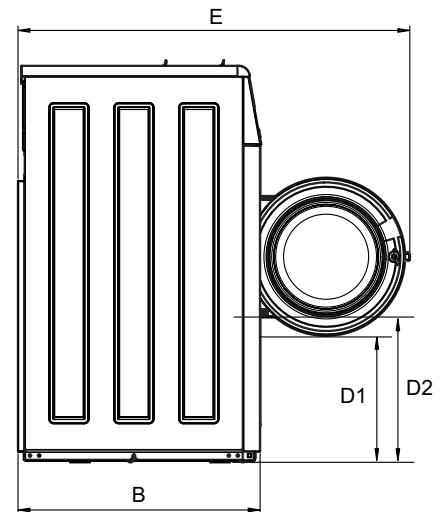

Side view

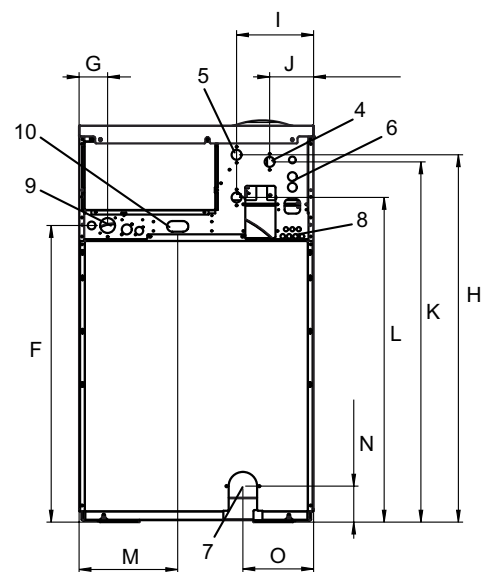

Rear